

**For applications**  
where precise Angle  
Measurement **under**  
**Extreme Conditions**  
is necessary

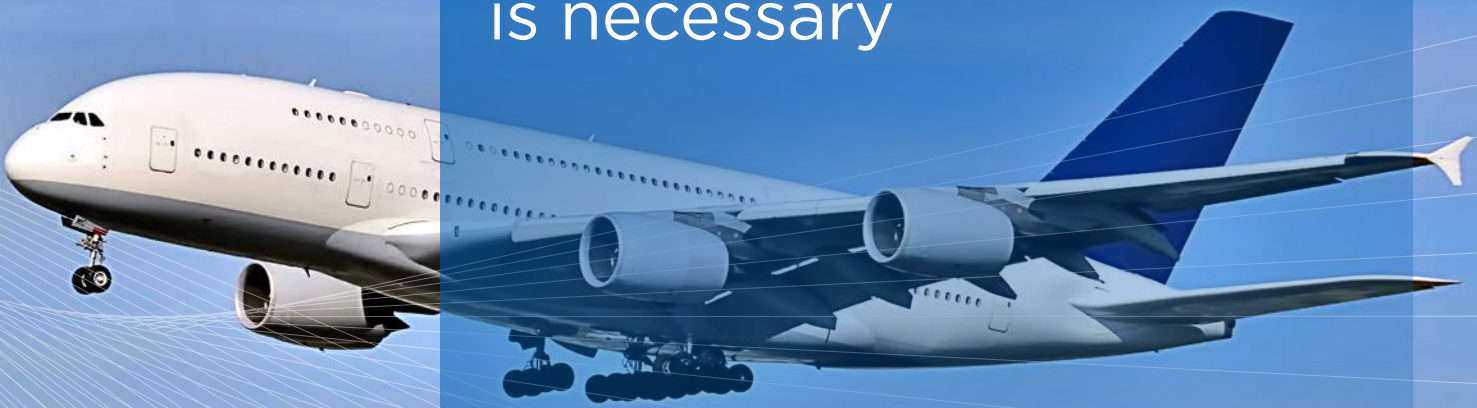

# Precise Angle Measurement under Extreme Conditions

## BENEFITS

No headaches with high speed

1

## ROTASYN SOLID ROTOR OFFERS UNIQUE ADVANTAGES:

- Full Metal Rotor, no insulation, no coils
- Double MTBF compared to brushless resolvers
- Riveted rotor construction
- Insensitivity to environmental conditions
- Angle of  $\pm 180^\circ$  when used as RVDT

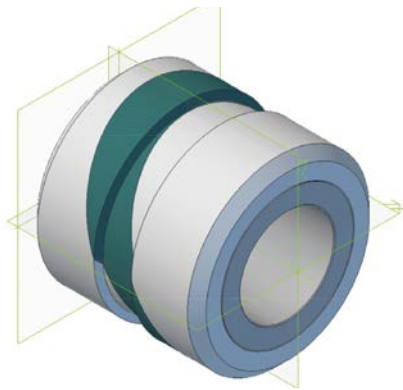

2

## ROTASYN DIFFERENTIAL TRANSFORMER PRINCIPLE OFFERS MANY ADVANTAGES:

- Analog Signal
- Very accurate and reproducible Zero Position (E. Z.)
- Absolute position over  $360^\circ$
- Practically no sensitivity to temperature in the range of  $-200^\circ\text{C}$  to  $+250^\circ\text{C}$
- PTFE or Kapton insulation
- Signal can be digitized with commercial RDC

## BENEFITS

Ratiometric sensor system very insensitive to EM perturbations

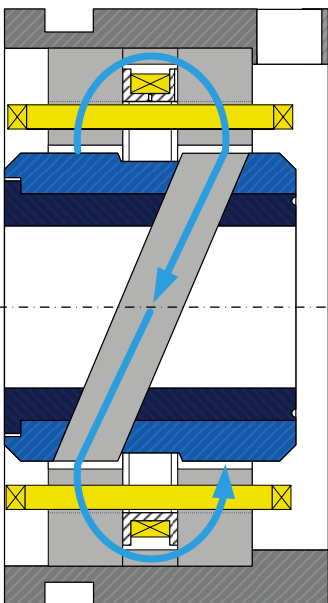

## 3

## AVAILABLE IN MANY STANDARD SIZES

### Standard Rotasyn Resolver Program

- Off the shelf sensors in many different sizes with short delivery at low costs
- Speed 1 (one pole pair)
- PTFE or Kapton insulation

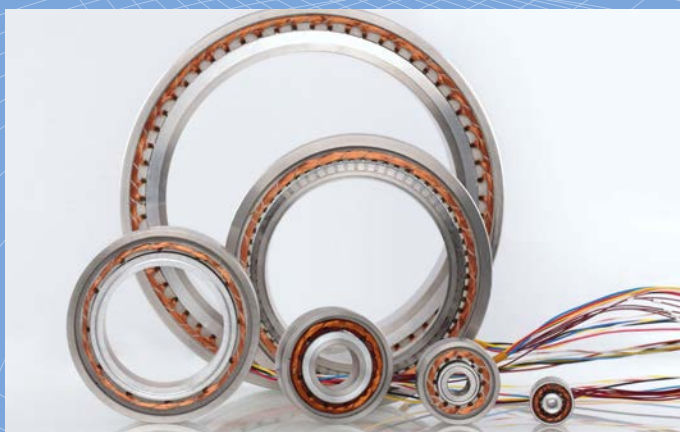

Rotasyn RO Series:  
Standard Resolvers Sizes

Size	Part No.	Stock	Stator OD	ID	Air Gap [mm]	Rotor OD	Rotor ID (max.)	Width Axis Direction
1/10"			[mm]	[mm]	[mm]	[mm]	[mm]	[mm]
08	RO2010	O	20	10	0.3	9.4	4	18
10	RO2613	-	26	13	0.3	12.4	6.35	20
15	RO3620	O	36.83	20	0.3	19.4	10 (12)	20
21	RO5032	O	50	32	0.3	31.4	20 (22)	20
24	RO6040	-	60	40	0.3	39.4	30	20
30	RO7557	O	75	57	0.3	56.4	45 (47)	22
34	RO8565	-	85	65	0.3	64.4	55	22
40	RO10080	-	100	80	0.5	79	65	22
50	RO125100	-	125	100	0.5	99	85	22
57	RO145125	-	145	125	0.5	124	107	22
72	RO185160	-	185	160	0.5	159	145	37
96	RO240200	-	240	200	0.5	199	185	38
116	RO290260	-	290	260	0.5	259	240	38

## 4

### CUSTOMIZED ROTASYN RESOLVERS



- To meet specific requirements
- Special windings
- Special sizes
- Large Air gap - up to 1mm
- External rotor
- Fast ROI: Admotec engineering provides optimal cost-effective solutions.

#### BENEFITS

Admotec will analyze your application and design a sensor solution to meet your demanding conditions of contamination, limited space, high temperature or high speed.



## 5

### MULTIPOLE RESOLVERS

- For 8 pole pairs and more
- Sizes 34 and larger

#### BENEFITS

Multipole resolvers are generally required for commutation of brushless motors with the same number of pole pairs

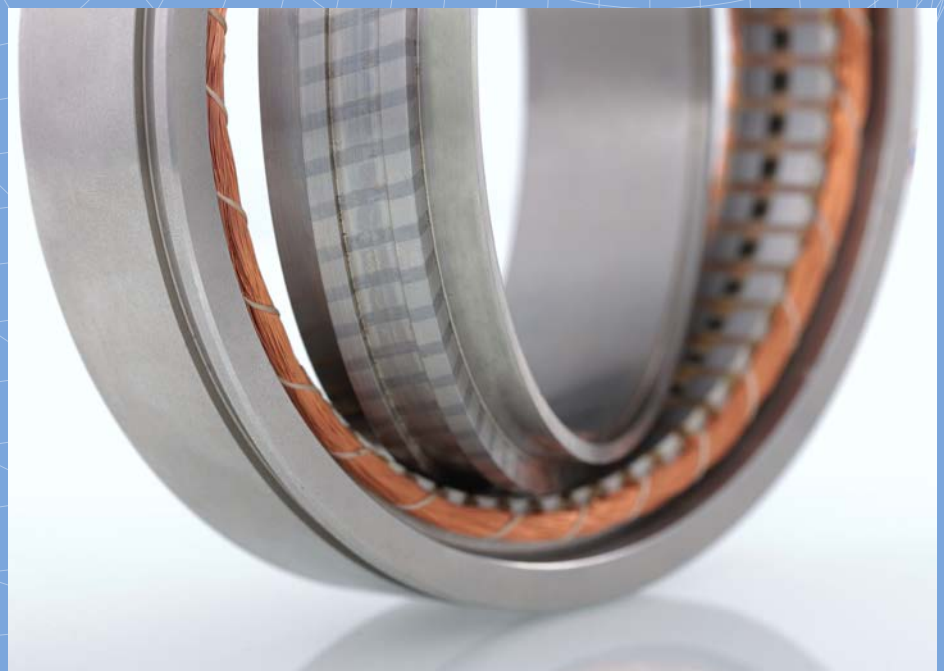

6

## ROTARY VARIABLE DIFFERENTIAL TRANSFORMERS RVDT



- Absolute Angular Transducer
- Reference Hole
- Sweep angle  $\pm 180^\circ$
- Hermetical Units

### BENEFITS

The absence of a rotating seal insures a longer life-time

7

## COMPLETE SENSOR TO DIGITAL OUTPUT SOLUTION

- Optimized Combination of Mechanical and Electrical Knowhow
- Resolver Measuring Benches
- Hi-Speed electrical motors

### BENEFITS

One stop solution Provides you an optimal function of your measuring problem

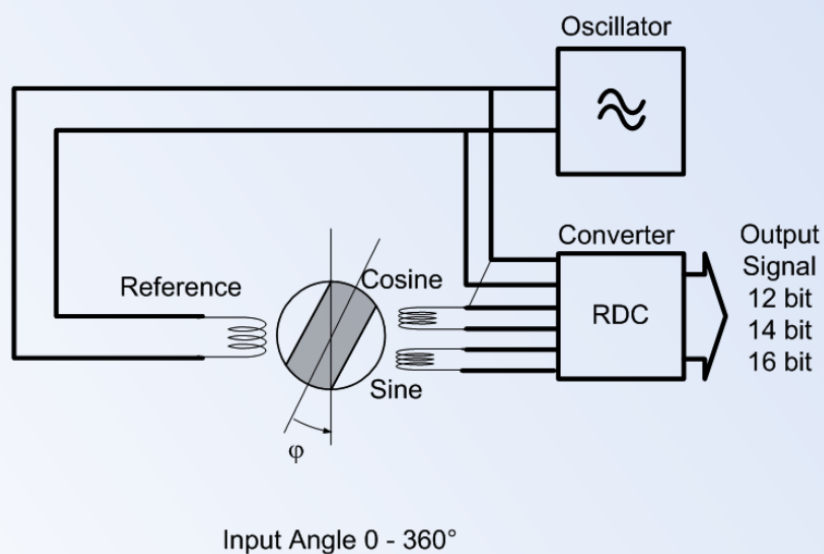

## ADMOTEC CAPABILITIES

- Many production technologies including e-beam and laser welding
- EN 9100 and ISO 9001 Certified

Many of Admotec's customers have come to our engineers when their traditional motion and sensing products do not last or fail in difficult environments. We urge you to contact us early in your design process. We will Admotec uses the latest chip-on-board and work with you through die-attach technology.

We will work with you through using our multi-disciplinary approach and broad-based application experience. We will help you develop, test and refine prototype motion sensing components. And we will work quickly to finalize designs and start production runs. We are, of course, always ready to sign confidentiality agreements to protect your entire design process. Let our experience and magnetic technology solve your most demanding motion and position sensing problems.



Admotec was founded in 1987 to develop, design, manufacture, and market motion and position sensors and transducers for original equipment manufacturers. Admotec is dedicated to applying leading-edge magnetic technologies and manufacturing techniques to the production of high-performance cost-effective solutions for measuring linear and rotary position, speed, and angle for a wide variety of aerospace, automotive and industrial applications.

# Glossary

## COMPARISON BETWEEN ROTASYN, BRUSHLESS RESOLVER AND RVDT

All 3 angular brushless sensors are rotating differential transformers with a precise E.Z. (Electrical zero) While the electrical design of Rotasyn and RVDT (Primary and secondary coils on stator, no coils on rotor) are similar, Brushless Resolver have primary coils on stator secondary coils on rotor and rotor fed by a rotating transformer.

Angular Sensor	Mechanical Design	Angular Range	Signal Input	Analog Signal Output	A/D Converter	Accuracy
<b>Rotasyn</b>	Frameless or housed	360°	Rotor Angle $\Phi$	absolute $U_2 \sin = TR \sin(\omega t) \sin \Phi$	RDC Resolver	Typically 20-40 Arcmin
	Housed with mech. zero reference	+/- 180°		$U_2 \cos = TR \sin(\omega t) \cos \Phi$ Phase shift at E.Z.	Digital Converter Resolution 12-16 Bit	Typically 0.1-0.2% of full scale
<b>Brushless Resolver</b>	Frameless or Housed	360°	Rotor Angle $\Phi$	absolute $U_2 \sin = TR \sin(\omega t) \sin \Phi$	RDC Resolver	Typically 10-20 Arcmin
	Housed	+/- 180°		$U_2 \cos = TR \sin(\omega t) \cos \Phi$ Phase shift at E.Z.	Digital Converter Resolution 12-16 Bit	
<b>RVDT</b>	Housed with mechanical zero reference	+/- 90°	Rotor Angle $\Phi$	absolute $U_2 = C \cdot U \sin(\omega t) \cdot \Phi$ Phase shift at $\Phi = 0^\circ$	Synchronous Demodulator	Typically 0.15-0.5% of full scale

# admotec

Advanced Motion Technology

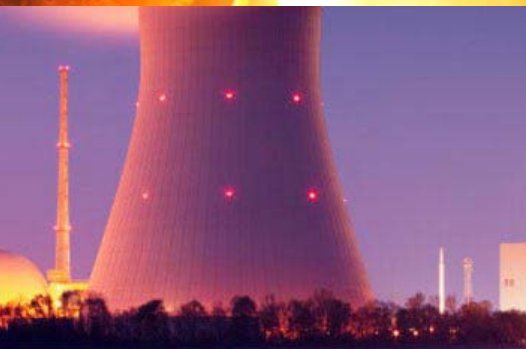

## APPLICATION DOMAINS

- **Aerospace**

Power Unit, Hi-Lift Control,  
Air Conditioning, Flaps Control,  
Brakes ABS

- **Electrical Motors**

Electronic Commutation, Speed  
loop and Position Loop Control

- **Automotive**

Turbocompressors, Starters,  
Hybrid Drives,

- **Industrial Automation**

Robots in extreme environment

- **Nuclear Energy and Research**

Motor Commutation, Motion  
Monitoring of Cooling Pumps and  
Fuel Rod Position

- **Ship Building**

Rudder Position Feedback

- **Oil Drilling Equipment**

Motor Commutation, Drilling  
Orientation

## OUR REFERENCES

**Airbus**

**Williams**

**Renault**

**Parker**

**Wittenstein**

**Safran**

**Ariane**

**UTC**

**AREVA**

### **Admotec Precision AG**

Kieselgasse 12  
CH-8008 Zürich  
Telefon +41 44 422 22 75  
Fax +41 44 422 22 76

### **Admotec Precision LLC**

27 Dunsinane Drive  
Lebanon 03766-2306, NH  
USA  
Tel +1 603.727.4921

[www.admotec.ch](http://www.admotec.ch)